

# SubQ It!®

REF 408010

Bioabsorbable Subcuticular Closure

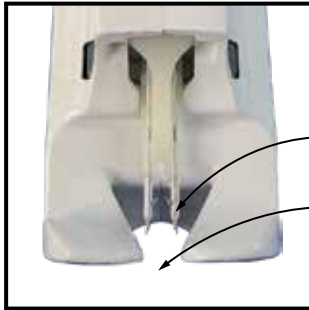
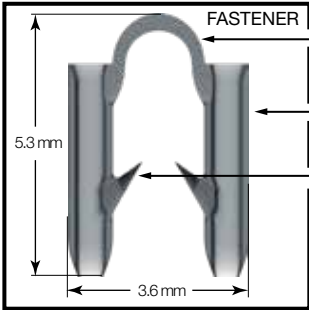

## DEVICE DESCRIPTION

**THE SUBQ IT! BIOABSORBABLE SUBCUTICULAR CLOSURE DEVICE** is comprised of a manual stapler preloaded with 10 bioabsorbable fasteners, sufficient for up to 6 short incisions requiring 1-2 fasteners each or an incision up to 10 cm long. The stapler inserts SubQ It! fasteners into the underside of the dermis that is exposed by everting the skin edges over the device feet to obtain wound closure.

**THE SUBQ IT! FASTENER** is only 5.3 mm long and weighs 0.006 grams. It is molded from a polyglycolic/poly-lactic acid copolymer, a well-established material for resorbable medical devices. Fasteners maintain 80% of their strength for 21 days to support healing and then degrades by hydrolysis and are absorbed by normal physiological processes in subsequent months.

 **READ INSTRUCTIONS FOR USE ON INSIDE PAGES**  
In-service training is necessary prior to clinical use of the SubQ It! system.





# INSTRUCTIONS FOR USE

Requires two people. Tasks for **ASSISTANT** and **SURGEON** are summarized here. These directions do not replace requirement for in-service training prior to clinical use.



## 1 Remove Safety Lock

**SURGEON:** Using Adson forceps, grasp dermal tissue to expose the underside 3-4 mm back from the wound edges.



## 2 Grasp Tissue with Adson Forceps

**ASSISTANT:** Using sterile technique, remove the SubQ It! Stapler from the foil pouch and remove the safety lock by a twisting/pulling motion.



## 3 Slide Stapler into Position

**SURGEON:** Bring forceps together and elevate to thin tissue and allow it to slide between stapler feet.

**ASSISTANT:** Use handle at base of stapler to advance stapler into position. If the tissue is thick, use other hand to apply reverse traction.

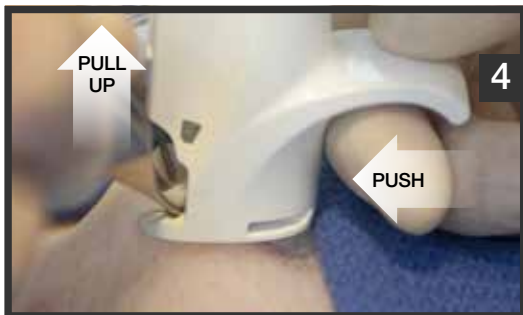

## 4 Press Forceps into Locators

**SURGEON:** Hold forceps at 45° angle and press tips securely into Forceps Locators..

**ASSISTANT:** Hold stapler up so surgeon can feel pressure against forceps locators and to ensure that tissue is not folded or slack.

# SubQ It!®

Bioabsorbable Subcuticular Closure



## 5 Press Plunger Down Until it Stops

**SURGEON:** Hold tissue FIRMLY resisting slippage while assistant deploys fastener.

**ASSISTANT:** Press plunger down in a smooth and deliberate motion until it stops.

**CAUTION:** If plunger is partially pressed and released, fastener may fall or jam stapler.

## Reposition for Additional Sutures

**SURGEON:** If additional sutures are needed grasp tissue immediately in front of stapler feet. This will provide spacing of 8-10mm between fasteners.

**ASSISTANT:** Keep stapler in place until surgeon grasps next bite, then slide forward and lift as in step 3.

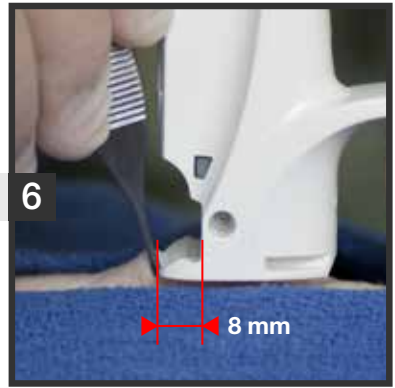

## 6

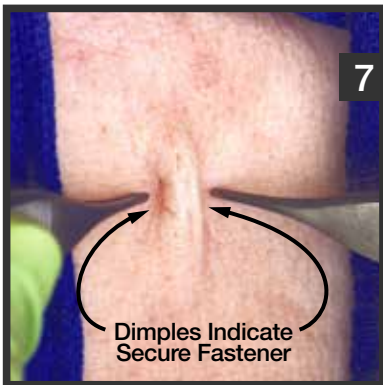

## 7

## Expected Appearance

**SURGEON:** Assess closure by spreading wound at the base near the dimples. Additional sutures may be placed between previous ones if needed.

## OTHER NOTES:

**ADSON FORCEPS:** Two mouse-tooth Adson forceps are recommended. If tissue slips out of forceps, Adson -Brown forceps may be used. Do not attempt to use smooth tipped forceps.

**IF FASTENER IS NOT SECURE:** If security of a fastener is questionable, it may be left in place, adding another fastener nearby to strengthen the incision. If an unsecured fastener is to be removed during surgery, pull gently on the unsecured leg with hemostat forceps. Clip the unsecured portion of the fastener with scissors close to the tissue and remove. Replace with another fastener.

**IF INCISION NEEDS TO BE REOPENED:** Use hemostat forceps to find and pinch bridge section of each fastener. Clip on each side of forceps close to the tissue with scissors and remove.

**NEEDLE DAMAGE:** Needles may be damaged if they strike forceps or other obstruction. Do not use if needles are bent or plunger does not operate smoothly. If any damage is suspected discard and replace device.

**POSTOPERATIVE CARE:** Apply postoperative dressing of choice for surgical incisions. With water tight dressings, the incision area may be bathed within 24 hours and dressing removed by the patient in 3-5 days.

**STORAGE:** Store at 15-30°C (59-86°F).

**DO NOT EXPOSE TO 49°C (120°F):** Keep away from heat. Do NOT use the SubQ It! device if the temperature dot on the shelf box is blackened.

**DISPOSAL:** Dispose of stapler in a designated sharps container.

# SubQ It!®

## Bioabsorbable Subcuticular Closure

### PRINCIPLES OF OPERATION

1. The barbed legs of the fastener are hollow and supported by surgical needles during insertion.
2. Once inserted, the needles are retracted leaving the fastener imbedded in the dermal tissue.
3. The barbs catch and the bridge flexes under tension, holding the two sides of the incision in apposition during the healing process.

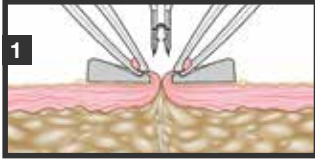

Adson Forceps used to fold each side of incision over foot to expose sub-dermal tissue.

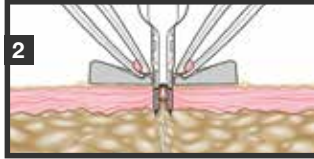

Needles drive fastener legs into tissue and then retract, barbs on each leg catch in tissue.



Legs spread angularly, incision is held together by tensile strength of the bridge.

**CAUTION: Federal (USA) law restricts this device to sale, distribution, and use by, or on the order of, a physician.**

### INDICATION FOR USE / INTENDED USE

The SubQ It! Bioabsorbable Subcuticular Closure Device is intended for use in humans for abdominal, thoracic, gynecologic, orthopedic, plastic and reconstructive surgery for the subcuticular closure of skin where an absorbable tissue fastener is desired for temporary tissue approximation.

### CONTRAINDICATIONS

1. Do not use on tissue that is too thin. Tissue is too thin if a full pinch is less than 3mm thick or dermis is less than 1mm thick.
2. Do not use on tissue that is too thick. Tissue is too thick if it cannot be inserted between the stapler feet.
3. Do not use on incisions through scar tissue as barbs may not engage securely.
4. Do not use as the sole closure modality on incisions under tension or incisions that will be placed under excessive force within 7 days of surgery. Other modalities should be used to relieve tension or secure skin apposition in conjunction with or instead of SubQ It!

### WARNING

1. DO NOT remove Safety Lock until ready for use. Note needle path and do not press plunger down if needle exposure would cause harm. A safety stop blocks needles from being exposed after last fastener is deployed. Do not attempt to force plunger down against safety stop.
2. Single Patient Use - DO NOT resterilize. Bioabsorbable fasteners are degraded by heat, humidity, and excess radiation.

### PRECAUTIONS

If critical tissue or other structures (e.g. nerve, tendon, vein, pacemaker, venous access port, etc.) are within 10mm of skin surface, hold stapler up while deploying suture to avoid striking object with needles.

### ADVERSE REACTIONS

Adverse reactions may include swelling, bruising, acute inflammation, erythema, edema, drainage, hematoma, surfacing fasteners, dehiscence, necrosis, scar widening, discoloration and hyperpigmentation.

Patents protecting this device:  
U.S. 8,506,591, 10,045,777 and  
9,232,943; China ZL 200780032463.4;  
Japan 5667976; Australia 2007269655;  
Canada 2,655,197; Hong Kong  
HK1123961; Europe EP 2,034,904 and  
2,762,089; other patents pending.

Manufacturer: Opus KSD, Inc.  
50 Corporate Park Dr. Ste 710  
Pembroke, MA 02359 USA  
Phone: +1 339 933 8811  
[www.subqit.com](http://www.subqit.com)

Fasteners and Needles Made in USA;  
Stapler assembled using U.S. and  
foreign parts in P.R.C.